

# K7 HEPA & K7 HEPA OH+FC purification unit



## INSTALLATION MANUAL, OPERATION AND MAINTENANCE



*Please read this instruction manual carefully before carrying out installation.  
Give this manual to the end user.*

### SAFETY WARNING SYMBOLS



*Attention, danger, warning of security!*



*!Danger!*



*Danger of injury!*



*Attention! Do not get under the load.  
High weight.*



*Important information.*



*Caution! Wear protective glasses  
UV-A: Ultraviolet radiation.*



# INDEX

## indice

INSTALLATION .....	4
TRANSPORT AND STORAGE.....	5
OPERATING INSTRUCTIONS.....	5
ELECTRICAL SCHEMES.....	6
DATASHEET.....	8
MAINTENANCE INSTRUCTIONS .....	12
REPAIRS AND REPLACEMENTS .....	13
ACCESSORIES.....	18
FAULTS AND SOLUTIONS .....	19
DECLARATION OF CONFORMITY .....	20
IDENTIFICATOR .....	21
WARRANTY .....	21

## INSTALLATION



Assembly, connection and disconnection, electrical wiring and maintenance must be carried out exclusively by qualified personnel, following this instruction manual and respecting the applicable regulations. In case of supplying a special control, a specific manual is attached that must be used for its installation and operation.



It is necessary to remove the service grill to connect the equipment. The electrical connection is made in an IP box located inside the equipment. The equipment mountings are external (in the standard model, located on the top or rear of the purifier). The unit has a service door to place the filters and a second panel to carry out repairs (see repairs section).

### Installation in false ceiling

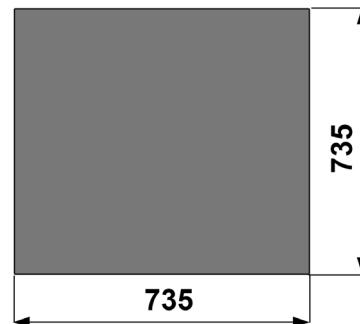
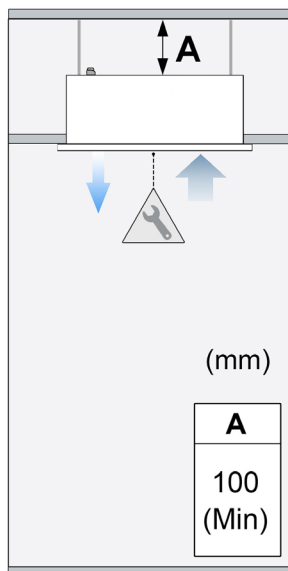
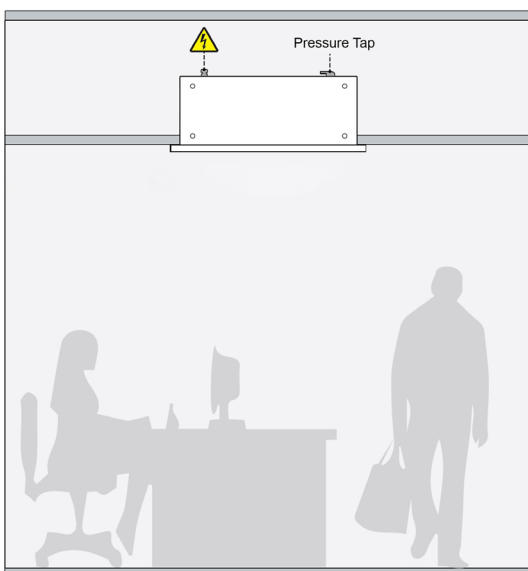

### Hanged installation

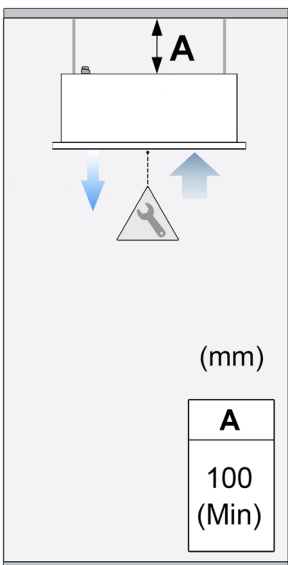
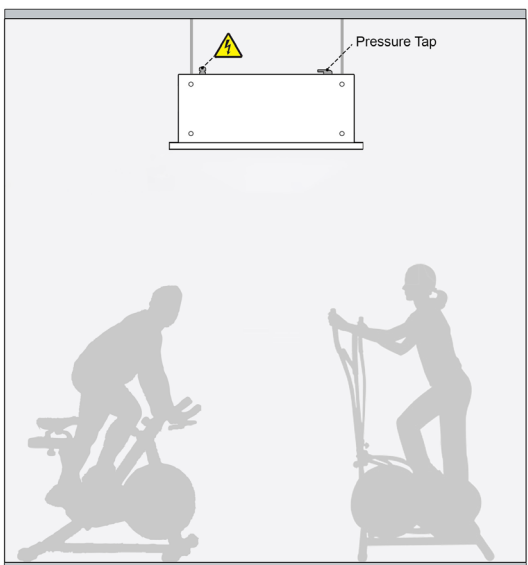

## Power supply

The K7 770 A HEPA air purifier has a 3 meter, 3-way cable (line, neutral and ground) that must be connected to a 230Vx1 50 / 60Hz power outlet.

A switch can be connected between the unit and the inlet power. Therefore you can disconnect the equipment in a simple way.

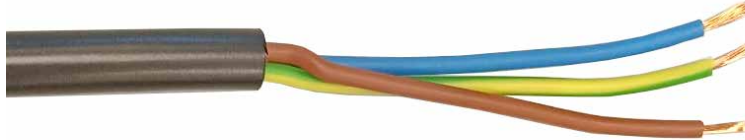

## Autoregulation

This unit provides a constant air flow of 300 m<sup>3</sup> / h. As the filters get dirty, K7 770 A HEPA regulates itself to maintain a constant flow.

The equipment is already factory adjusted by default. It only needs to be powered with 230Vx1 50 / 60Hz current.

## Fixings

The equipment has several external attachment points located in the casing, either in the top, front and back sides. The anchor must be sized according to the device weights indicated on the technical data page (see pages 6-7). The installation can be carried out with threaded rods, tensioners or other supports (see section "accessories").

## TRANSPORT AND STORAGE



**ATTENTION! Heavy object.**  
**Do not stand under the suspended load during transport or assembly.**

Store in a dry place and protected from the environment. If the packaging is opened, cover the purifier to protect it from dust. Do not step on or place heavy loads on it to avoid damage to the material. Storage temperature between -20°C and + 40°C.

When transporting the material you must ensure that it is not damaged by the forklift (possible penetration of the fork in the packaging). Observe the instructions on the packaging.

## OPERATING INSTRUCTIONS

To put the device into operation, just connect it to a voltage of 230Vx1 50 / 60Hz, as indicated in the electrical diagram on the next page. This device works with a constant flow rate that the user does not need to configure. The fan regulates itself to maintain a flow rate of 300m<sup>3</sup> / h until the filters are dirty. When the filters are no longer able to hold particles, a red light comes on. This indicates that dirty filters should be replaced with clean ones. Furthermore, the team cannot guarantee that the flow (and consequently the renewals / hour) will be maintained until clean filters are installed.

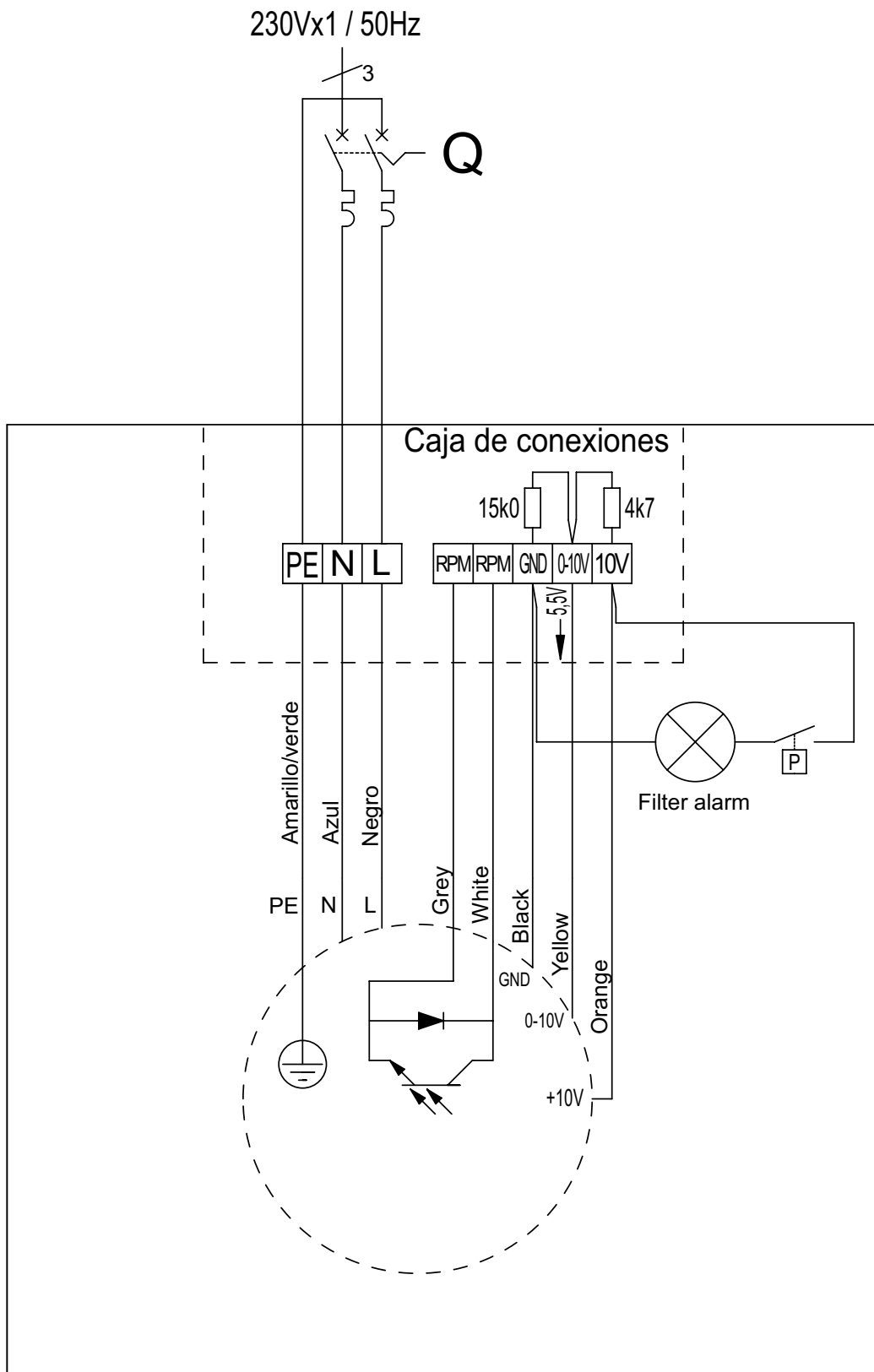

K7 770 HEPA



ESQUEMAS ELÉCTRICOS DE UNIDADES DE VENTILACIÓN  
 WIRING DIAGRAMS OF VENTILATION UNITS  
 K7 770 HEPA Caudal constante Regulación fija

Pág./ Page 1 de/ of 1  
 Doc. AIRDOM50106  
 R0 - 04/11/21

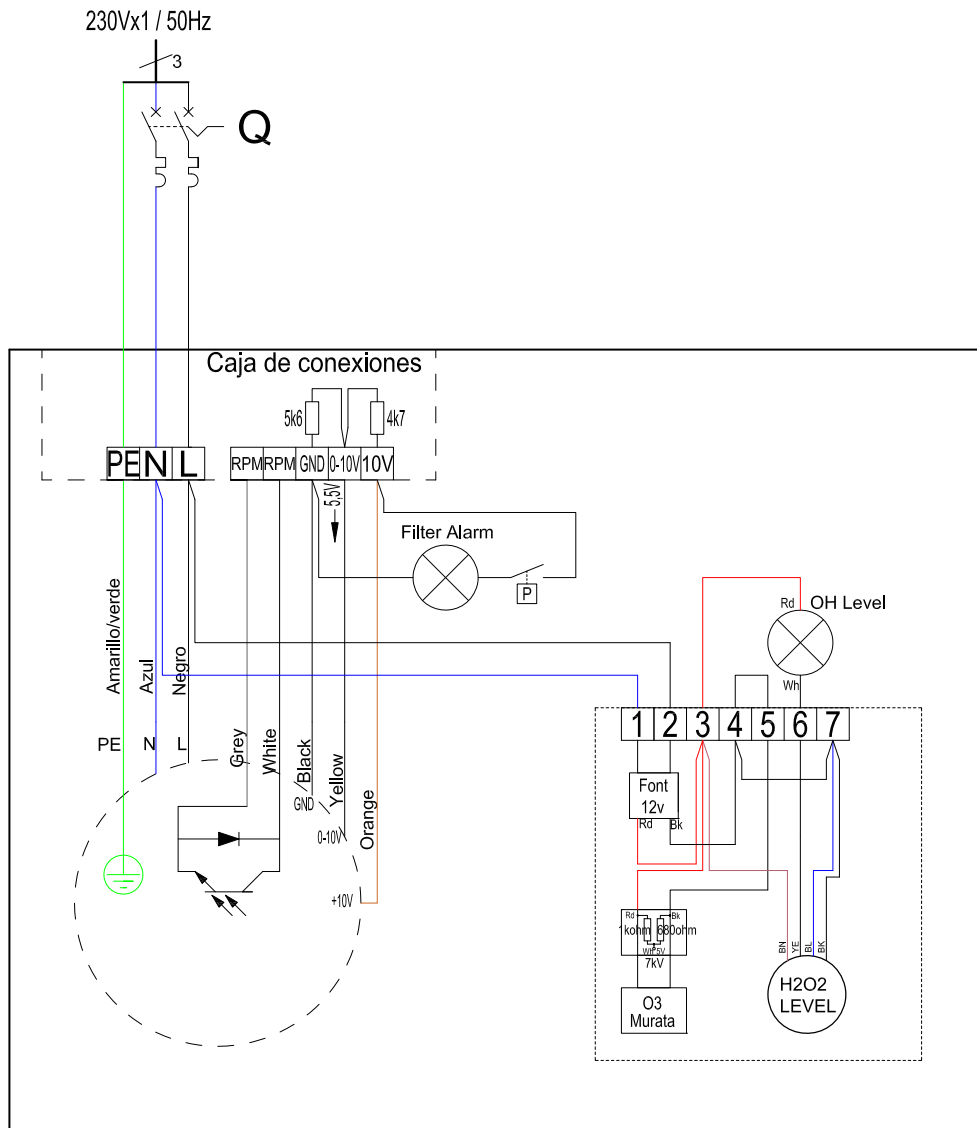

K7 770 HEPA UV OH





ESQUEMAS ELÉCTRICOS DE UNIDADES DE VENTILACIÓN  
 WIRING DIAGRAMS OF VENTILATION UNITS

K7 770 HEPA Caudal constante Reg fija

Pág./ Page 1 de/ of 1  
 Doc. WELDOE07065  
 R0 - 04/11/21

# DATASHEET

K7 770 HEPA

				
Airflow (m <sup>3</sup> /h)	Consumption (W/h)	Intensity (A at 230V-50Hz)	Weight (Kg)	Noise level (dBA)
300	61	0,7	32	55

## Dimensions

The device has a compact design with overall dimensions of 770 x 770 x 210 (mm).

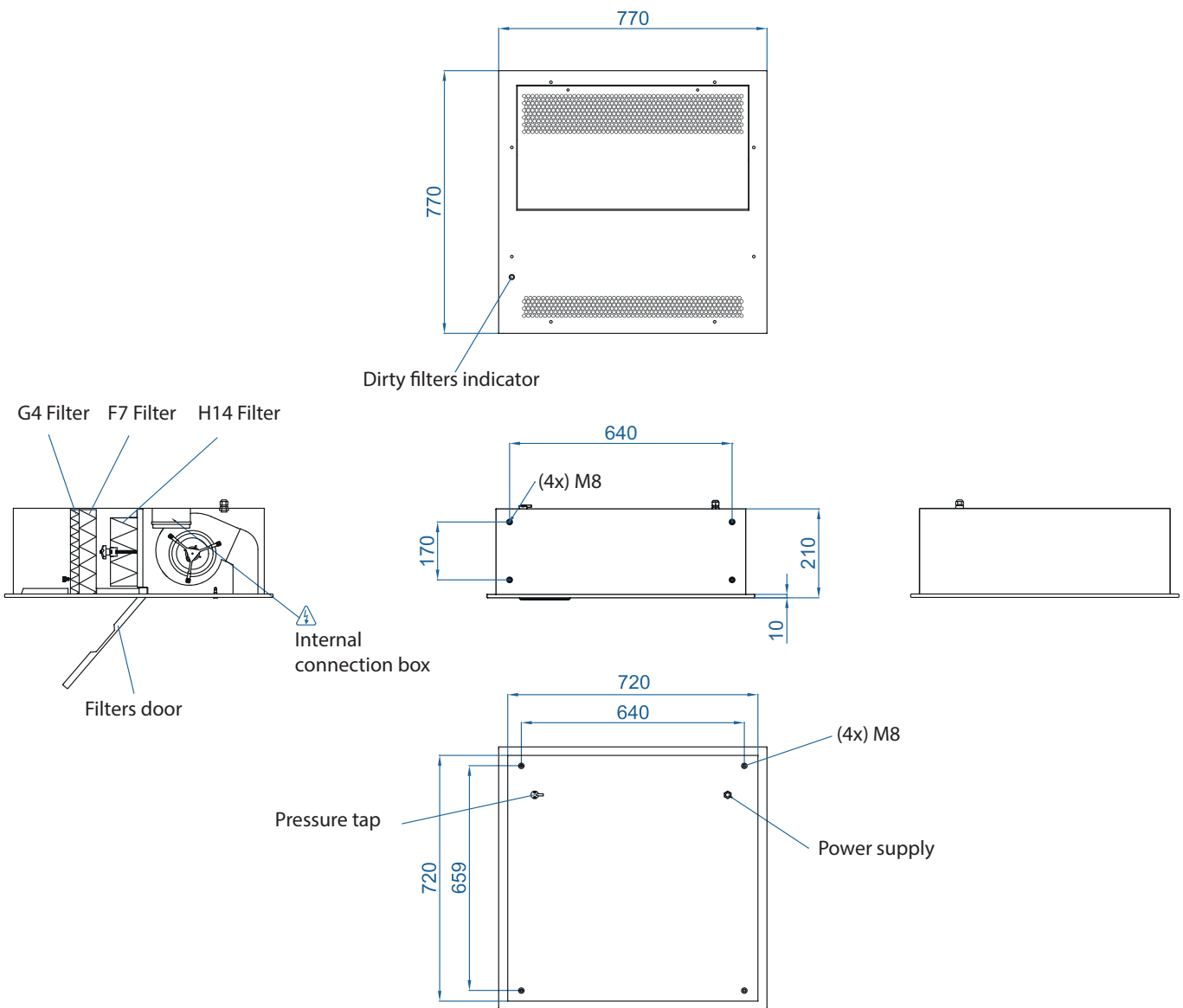







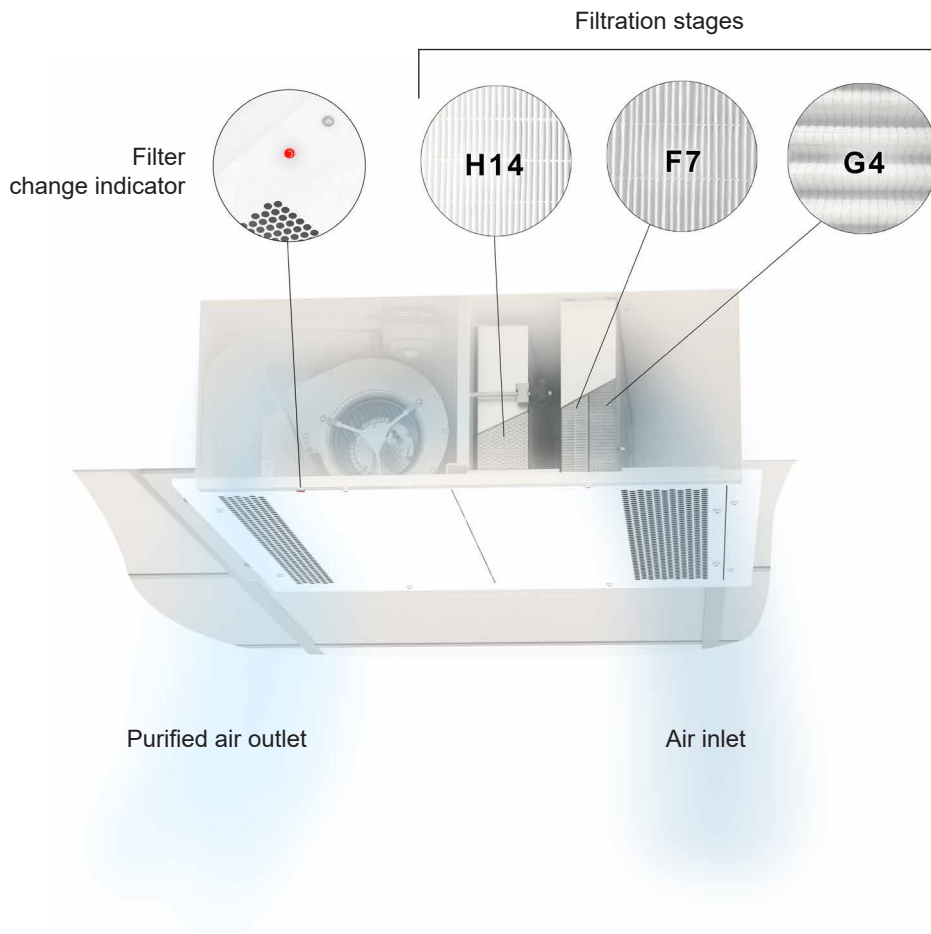

## Functioning

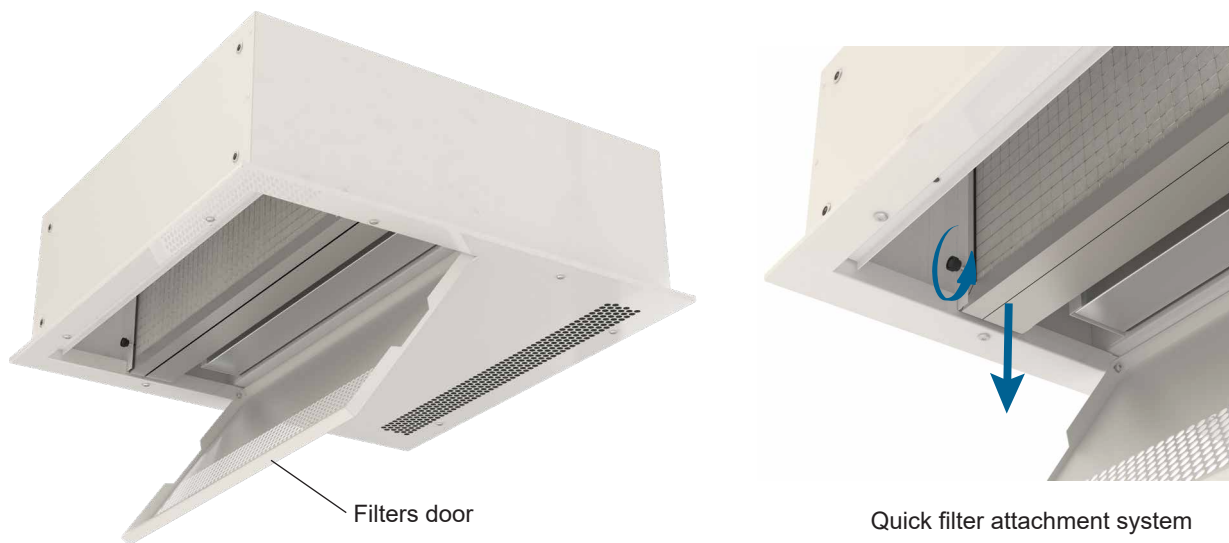
The unit has 3 filtration stages: 2 pre-filters (G4 and F7) and an absolute filter (H14). The LED on the service panel indicates the filter change to be carried out to maintain the efficiency of the equipment.



## Maintenance



					
Airflow (m <sup>3</sup> /h)	Consumption (W/h)	Intensity (A at 230V-50Hz)	Weight (Kg)	Noise level (dBA)	Range (m <sup>3</sup> )
300	61	0,7	32	55	850

## Dimensions

The device has a compact design with overall dimensions of 770 x 770 x 210 (mm).

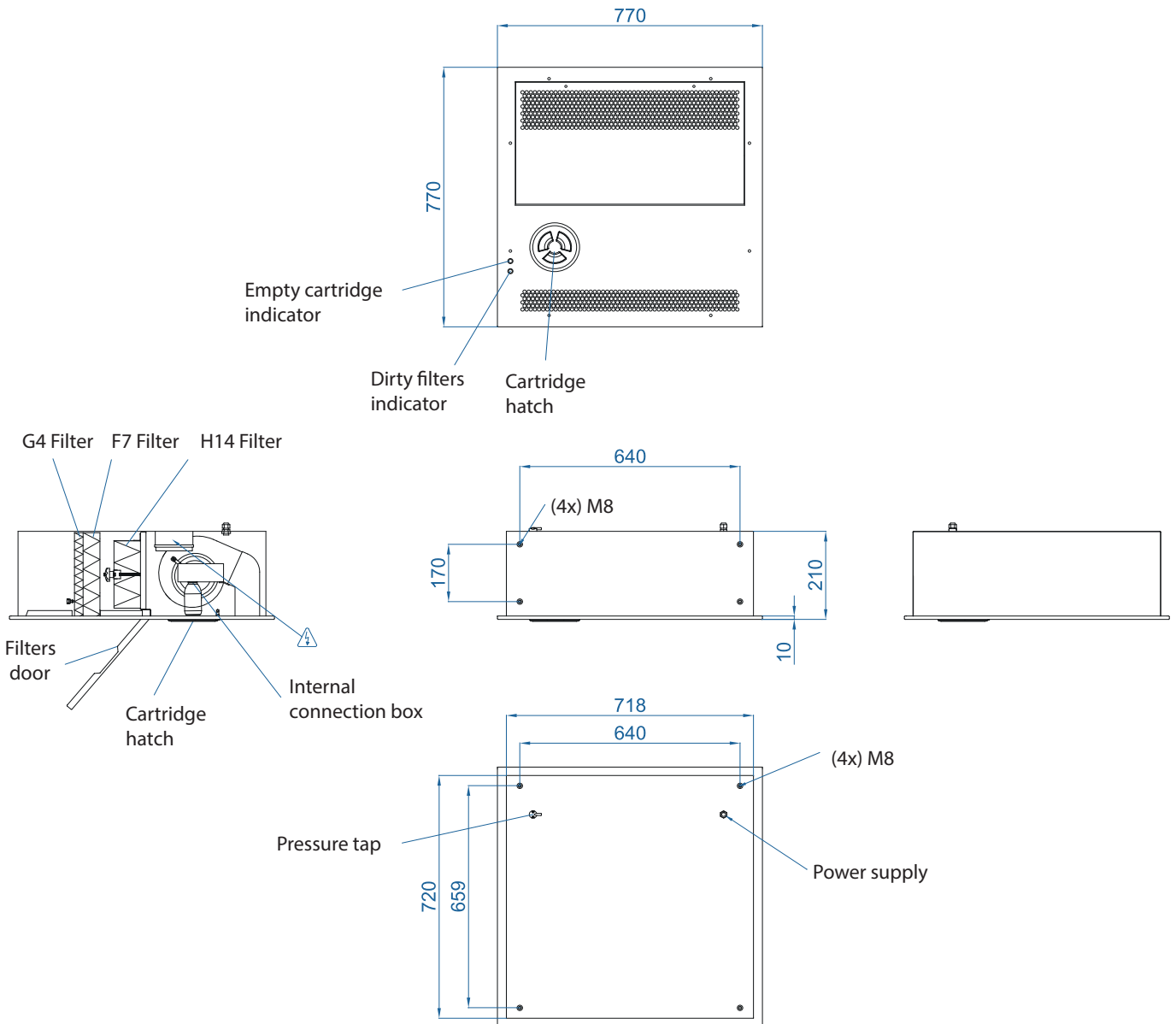

## Functioning

Three air and surface purification and disinfection systems in a single unit. Air recirculation through a HEPA filter and expansion of hydroxyls thanks to active OH technology and photocatalysis fan guarantee a space free of pathogens and other volatile organic compounds that pollute indoor air.

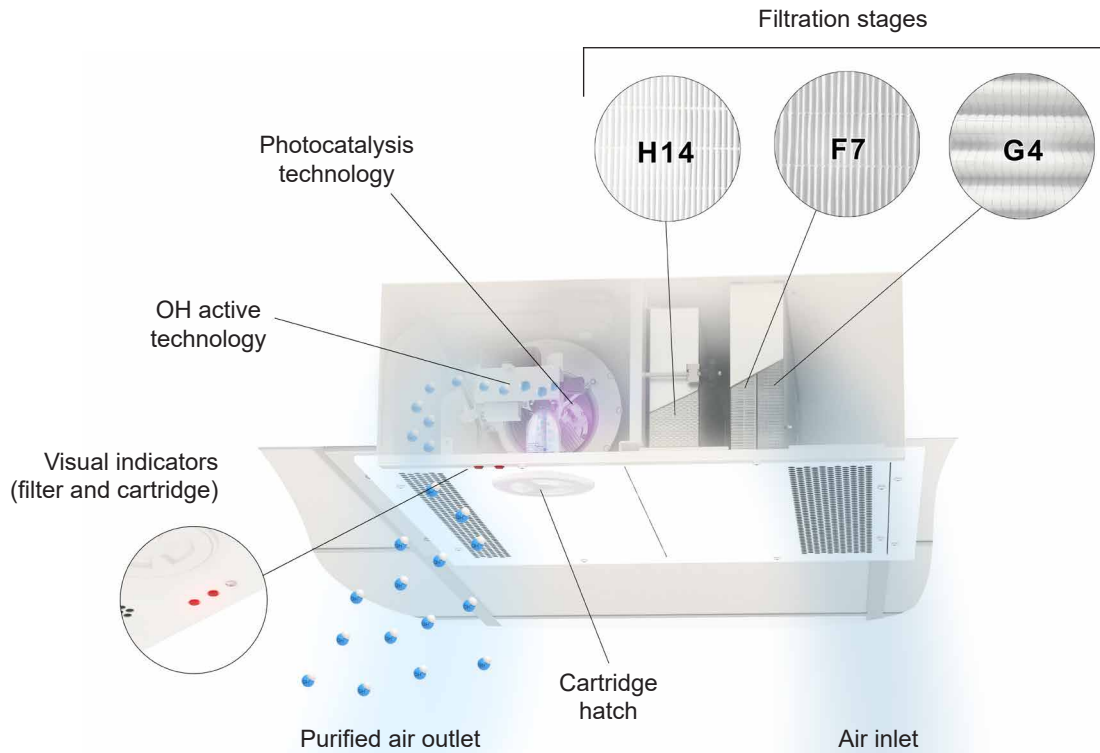

The LED on the service panel indicates either the filter or cartridge change to be carried out to maintain the efficiency of the equipment.

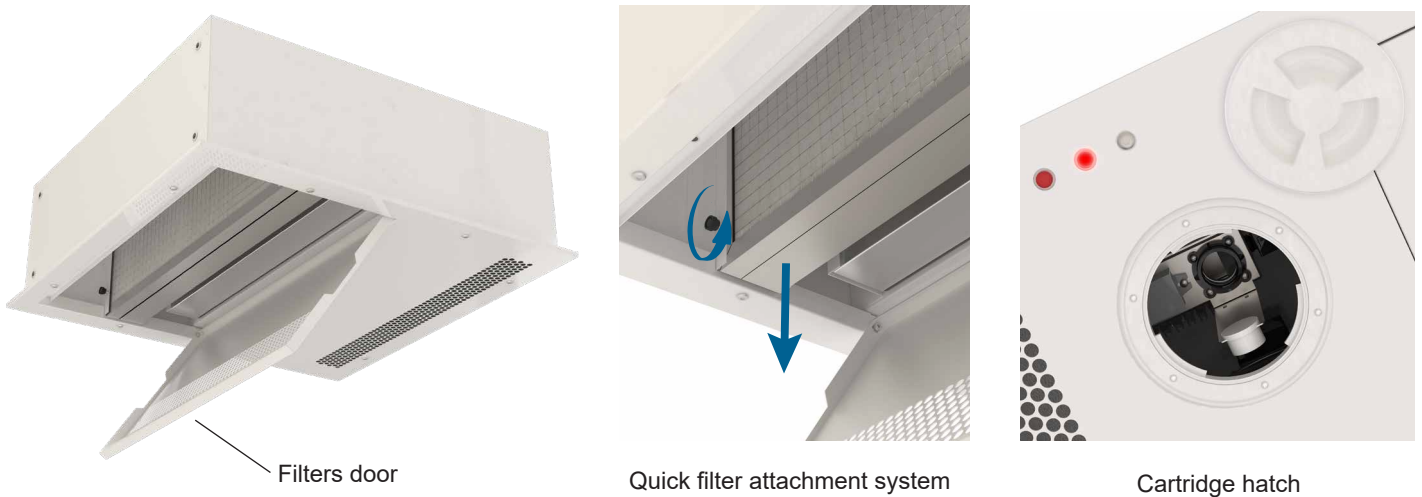

## Maintenance



## MAINTENANCE INSTRUCTIONS

	<b>For safety, before cleaning, disconnect the device from the power.</b>
	<b>It is forbidden to open the service panel (risk of electric shock and trapping in the fans). Repairs must be carried out exclusively by authorized personnel.</b>
	<b>The interior of the device must not be cleaned with water or steam.</b>

### Exterior cleaning

It is recommended to clean the air inlet grille with a damp cloth. Cleaning must be done with the unit off; the mixture of dust and moisture generates a paste that could enter and affect the internal components, rendering them unusable before the estimated deadline. An annual cleaning of the air outlet area should be performed.

Cleaning of the unit casing should be done with a damp cloth and conventional detergent. Do not use corrosive, caustic or acid-containing detergents.

The air inlet grille prevents objects from entering the internal area. A periodical checking is convenient to ensure that it is free of any object that could prevent the entry of air (papers, plastics, etc.).



### Interior cleaning

In models with perforated grille, it is advisable to clean the inside of the unit with a vacuum cleaner, at least once every two years (\*), and by qualified personnel.

(\*) This period of time is indicative, it depends on the conditions of each installation.

In places with a high number of suspended particles (a lot of dust and dirt) it is desirable increase the frequency of interior cleaning.

## REPAIRS AND REPLACEMENTS

**The assembly and electrical connection must be carried out exclusively by specialized professionals and observing these instructions.**

**Before carrying out any repairs, you must:**



- **Notify staff and indicate that work is in progress.**
- **Disconnect the current and protect the thermal magnet**



- (so that no one can actuate it by accident)
- **Make sure there is no voltage on the unit.**



- **Make sure the fan has stopped.**
- **Use only original spare parts.**

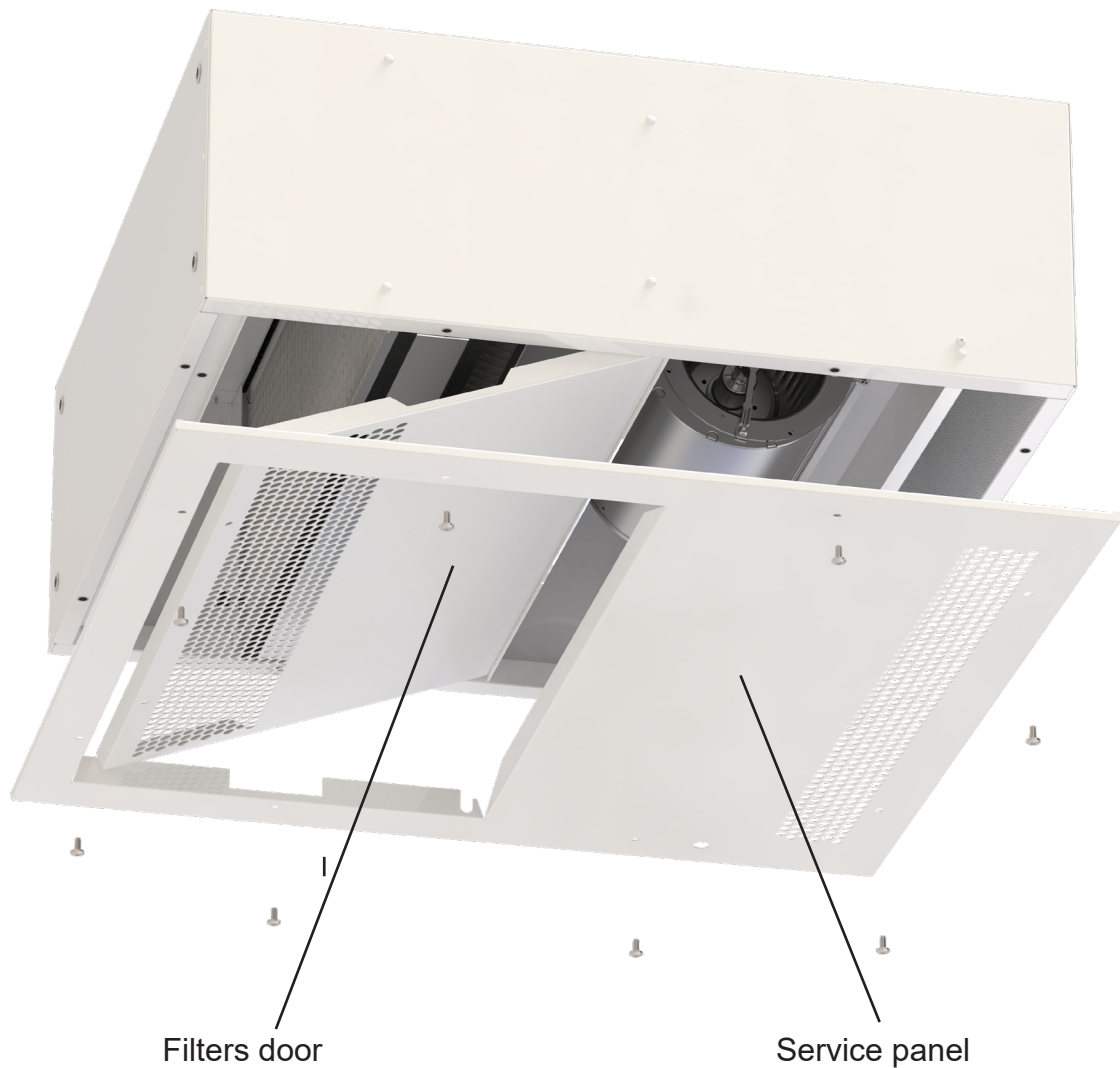

Filters door

Service panel

**The assembly and electrical connection must be carried out exclusively by specialized professionals and observing these instructions.**

**Before carrying out any repairs, you must:**



• **Notify staff and indicate that work is in progress.**



• **Disconnect the current and protect the thermal magnet (so that no one can actuate it by accident)**



• **Make sure there is no voltage on the unit.**

• **Make sure the fan has stopped.**

• **Use only original spare parts.**

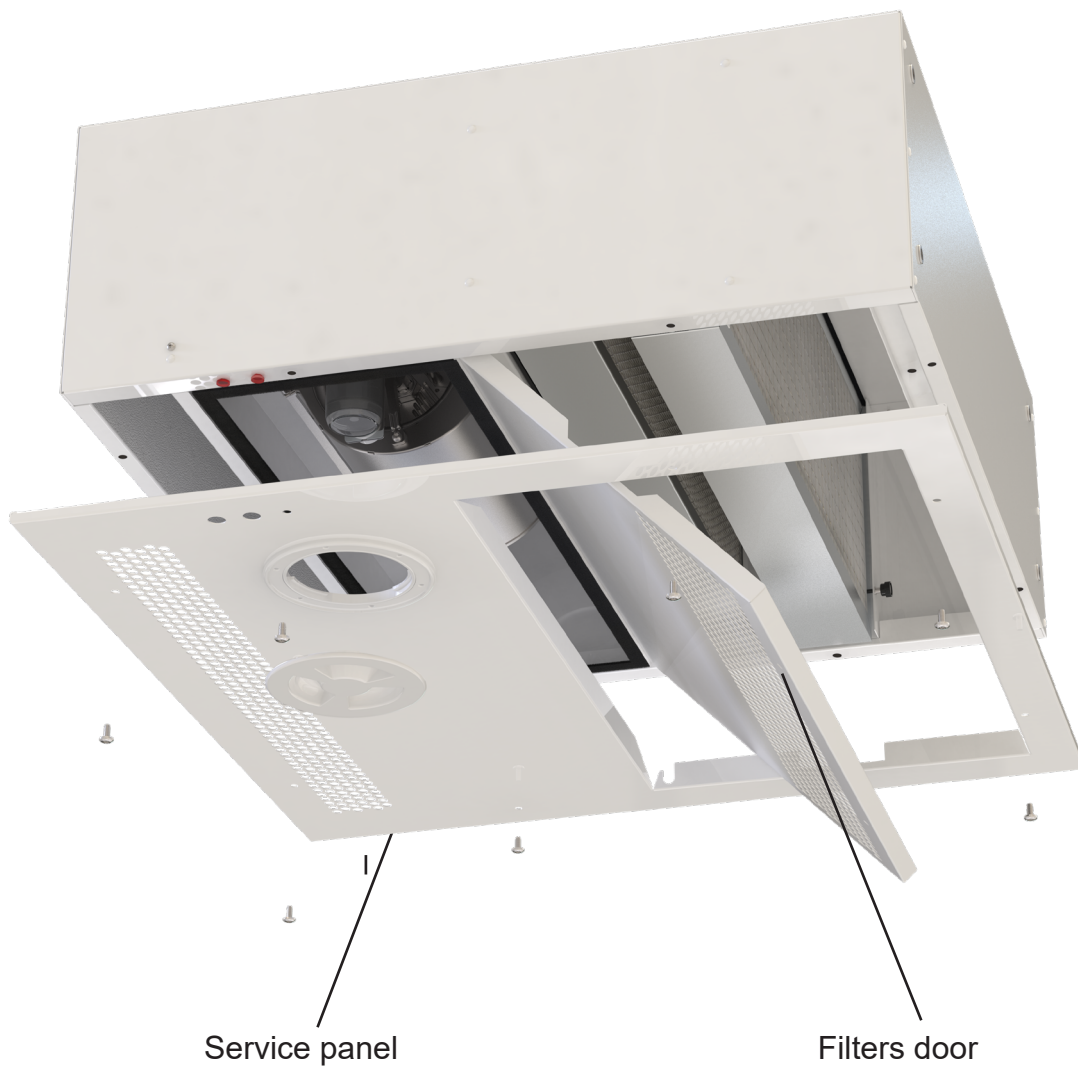

## Filters replacement

The estimated useful life (\*) of the filters under normal operating conditions is:

- Prefilter G4: 500 hours.
- Compact filter F7: 1000 hours.
- Absolut filter H14: 3500 hours.

It is recommended to check the condition of the filters every six months, even if the stipulated time has not passed or the filter change alarm has not triggered.

Before changing the filters, check and indicate that it is working and stop the unit with the corresponding command.



1- Remove the screws.



2- Gently, pull the grille down.



Filters doors opened



3- Loosen the threaded knobs on the pre-filter.



4- Remove prefilters.



5- Loosen the threaded knobs and staples of the absolute

5.1

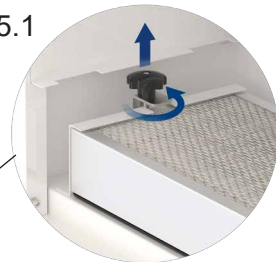

5.2



6- Remove the absolute filter pulling gently.

Replace the used filters with the new ones following the steps described, in reverse order..

(\*) This period of time is indicative, it depends on the conditions of each installation. In places with a high number of suspended particles (a lot of dust and dirt) it is desirable to increase the frequency of interior cleaning.

## Service panel opening

The service panel covers the inside of the unit. Through it you can access the fans and the connection box.



1- Remove the screws



2- Gently remove the service panel down



Service panel opened

## Fan replacement

Before replacing the fan, it is necessary to notify that it is working, disconnect the current, make sure that there is no voltage and the turbine does not rotate.

Open the service panel as indicated in the previous section.

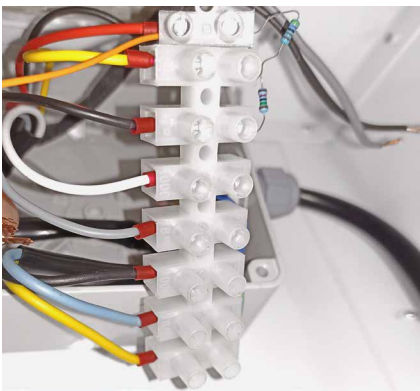

1- Disconnect the fan power cables inside the connection box



2- Remove the screws



3- Remove fan

The new fan is installed following the above procedure in reverse order, making sure that the connection in the IP box is correct (follow instructions on page 4).



## Cartridge replacement



The cartridge only needs to be changed every 3 months. The level of the cartridge is controlled by a sensor that will warn when the liquid runs out so that it can be replaced.

## Additional Information

One of the technologies of the disinfection device is implemented with an ultraviolet ray emitting LED which, as it is inserted inside the housing of the unit and uses low intensity powers, is completely harmless to humans, because its incidence is not direct on living beings, but on the titanium dioxide coated fan.

According to UNE-EN 12198 the K7 is classified as category 0 but for the information of users and maintenance team its been identified with category 1 label.

Classification of machinery according to emission levels (UNE-EN 12198)

Category	Restrictions and security measures	Information and training
0	No restrictions	No information required
1	Restrictions: limited access, security measures may be necessary.	Information on hazards, risks and side effects
2	Special restrictions and essential security measures	Information on hazards, risks and side-effects; training may be needed



Optical radiation emission  
Category 1  
(EN 12198)

Source: Spanish Normalization UNE-EN 12198

## ACCESSORIES

Supports and shock absorbers according to installation (see references in attached document).



Silentblock in angle



Standard cable clamp

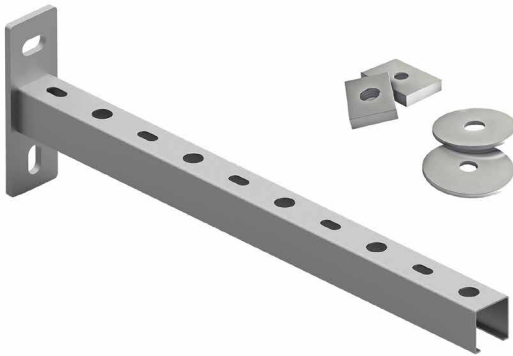

Rail support



Silentblock rod damper



### Electrical power supply

*If the equipment is not working, the error is most likely due to an incorrect terminal power.*

*1 - Check that it has been connected to a live electrical outlet.*

*2 - Check that the current is compatible with the equipment and that the terminal block cables are connected according to the electrical diagram specified in this manual.*

*3- Check that voltage (230Vx1) reaches the equipment and, if not, check the power cables.*

*3.1 - If the equipment has voltage, but the fan does not rotate, check if there is 5.5V in continuous between the yellow and black cables.*

*3.2 - In case there is no 5.5V, check that there is 10V in continuous between the orange and black cables. If there is 10V, one of the resistors has been damaged and must be replaced.*

*3.3 - If there is no 10V, the fan's 10V signal is damaged, the fan needs to be replaced.*



### Filters replacements

*If the equipment has a luminous red signal light on, it means that the filters are fully dirty and must be replaced (page 10).*

## DECLARATION OF CONFORMITY



### Declaration of conformity / Declaración de conformidad

Manufacturer **Motors i Ventiladors S.L. (AIRTÈCNICS)**  
Fabricante **Conca de Barberà 6, Pol. Ind. Pla de la Bruguera**  
**08211 Castellar del Vallès (Barcelona) Spain**

We declare, under our sole responsibility, that the product  
*Declaramos, bajo nuestra única responsabilidad, que el producto*

**Air Purification Equipment**  
***Equipo de Purificación del Aire***

with models  
*con los modelos*

**K7 770 Hepa**

is/are developed, designed and manufactured in accordance with the following directive(s)  
*ha(n) sido desarrollado(s), diseñado(s) y fabricado(s) de acuerdo con la(s) siguiente(s) directiva(s)*

**Low Voltage Directive 2014/35/UE**  
***Directiva Baja Tensión 2014/35/UE***

**Electromagnetic Compatibility Directive 2014/30/UE**  
***Directiva Compatibilidad Electromagnética 2014/30/UE***

**Restriction Certain Hazardous Substances Directive 2011/65/EU (RoHS)**  
***Directiva Restricción Substancias Peligrosas 2011/65/EU***

**Eco-design Energy-related Products Directive 2009/125/EC**  
***Directiva Diseño Ecológico Productos Con Energía 2009/125/CE***

applying the following harmonized standards in particular  
*aplicando las siguientes normas armonizadas en particular*

**LVD:** EN 60335-1:2012 / AC:2014 / A11:2014 / A13:2017 / A14:2020  
EN 60335-2-30:2009 / A11:2012  
EN 60335-2-65:2003 / A1:2008 / A11:2012

**EMC:** EN 61000-3-11:2000  
EN 61000-3-12:2011  
EN 55014-1:2017  
EN 55014-2:2015

**RoHS:** EN 50581:2012

Date / Fecha  
Name / Nombre  
Position / Cargo

01/12/2021  
**Jordi Hierro**  
Technical Manager / Director Técnico

  
**MOTORS I VENTILADORS, S.L.**  
ESB58967183 - C/ Conca de Barberà, 6  
08211 Castellar del Vallès  
Tel. 937159988 - Fax 937159989

Declaration  of conformity / Declaración  de conformidad

Manufacturer **Motors i Ventiladors S.L. (AIRTÈCNICS)**  
Fabricante **Conca de Barberà 6, Pol. Ind. Pla de la Bruguera**  
**08211 Castellar del Vallès (Barcelona) Spain**

We declare, under our sole responsibility, that the product  
*Declaramos, bajo nuestra única responsabilidad, que el producto*

**Air Purification Equipment**  
***Equipo de Purificación del Aire***

with models  
*con los modelos*

**K7 770 Hepa + OH + FC**

is/are developed, designed and manufactured in accordance with the following directive(s)  
*ha(n) sido desarrollado(s), diseñado(s) y fabricado(s) de acuerdo con la(s) siguiente(s) directiva(s)*

**Low Voltage Directive 2014/35/EU**  
***Directiva Baja Tensión 2014/35/UE***

**Electromagnetic Compatibility Directive 2014/30/EU**  
***Directiva Compatibilidad Electromagnética 2014/30/UE***

**Restriction Certain Hazardous Substances Directive 2011/65/EU (RoHS)**  
***Directiva Restricción Substancias Peligrosas 2011/65/UE***

**Eco-design Energy-related Products Directive 2009/125/EC**  
***Directiva Diseño Ecológico Productos Con Energía 2009/125/CE***

applying the following harmonized standards in particular  
*aplicando las siguientes normas armonizadas en particular*

**LVD:** EN 60335-1:2012 + AC:2014 + A11:2014 + A13:2017 + A1:2019 +  
A14:2019 + A2:2019  
EN 60335-2-30:2009 + A11:2012 + A1:2020 + A12:2020  
EN 60335-2-65:2003 + A1:2008 + A11:2012  
EN62471:2008

**EMC:** EN 61000-3-11:2002  
EN 61000-3-12:2011  
EN 55014-1:2017 + A11:2020  
EN 55014-2:2021

**RoHS:** EN 50581:2012

Date / Fecha  
Name / Nombre  
Position / Cargo

08/02/2023  
Jordi Hierro  
Technical Manager / Director Técnico

**MOTORS I VENTILADORS, S.L.**  
ESB58967183 - C/ Conca de Barberà, 6  
08211 Castellar del Vallès  
Tel. 937159988 - Fax 937159989

## IDENTIFICATOR



Conca de Barbera 6 - Pla de la Bruiguera  
08211 Castellar del Valles - BCN (SPAIN)  
Tel +34 93 7159988 www.airtecnics.com

Model: **K7 770 A FC+H14**  
Code: **AIRWEL70105**  
Dimensions:  
Motor:  
Tension: 220 V  
Frequency: 50 Hz  
Intensity: 0,68 A  
Power: 0,061 kW  
Fan:  
Speed: rpm  
Capacitor: microF  
Air Volume: 300 m3/h  
Filter:  
Pre-Filter:  
Filter:

All air purifiers are identified by a unique serial number printed on a label located on the inside of the service door. It also indicates the purifier model and its technical characteristics (flow rate, technical data of the fans). It is essential to have this number to provide possible spare parts or technical information on the purifier in question. In case of detecting errors or ambiguities in this manual, contact Airtècnics to resolve it and improve the documentation. Airtècnics reserves the right to change any of the specifications in this manual.

Customer:  
Order n°: Fab n°: **EXPROT 18** Serial n°: **4421 V 405.072**

**CE** Before use observe security rules and operating instructions!  
Avant la mise en service, observer les prescriptions de sécurité et le manuel d'utilisation !  
Antes de su puesta en marcha consultar el manual de instrucciones y normas de seguridad!



## WARRANTY

The warranty extends for one calendar year from the date of delivery. The guarantee is limited to repairing or replacing from our warehouse the products that eventually suffer breakdowns attributable to production defects. Installation costs are borne by the buyer. Products that in our opinion have been used improperly, handled incorrectly, improperly installed, connected to voltages other than the nominal, modified or repaired by unauthorized personnel, or that have suffered damage during transport, are excluded from any guarantee.

*For the validity of this guarantee, it will be essential that it be correctly completed and accompanied by the invoice that proves the date of purchase. In the case of being tampered with, it will lose its validity. It is the sole responsibility of the buyer to take the necessary security measures so that, in the event of a failure of one of the products, no damage occurs to third-party equipment, facilities or people.*



### Warranty card

**Purificator data:**

Model: ..... Serial number: .....  
Invoice date: ..... Invoice number: .....

**Buyer data:**

Name: .....  
Adress: .....  
Country: ..... Telephone:..... Fax:.....

**Seller data:**

Name: .....  
Adress: .....  
Country: ..... Telephone:..... Fax:.....

**Seal and sign from the buyer**

**Seal and sign from the seller**



*If you detect any errors in this manual, we will be happy to receive your comments, it helps us to continue improving. Airtècnics reserves the right to modify any of the specifications in this manual.*



Conca de Barberà, 6 - Pol. Ind. Pla de la Bruguera  
E-08211 Castellar del Vallès (Barcelona) Spain  
☎+ 34 93 715 99 88  
airtechnics@airtechnics.com

**[www.airtechnics.com](http://www.airtechnics.com)**



WELDOM10030-R0(08/02/23)

*We reserve the right to change design and specifications without prior notice.*